



# Astra 2

## Datasheet v1.0



Product Brief	02
Product Specifications	03
Product Information	04
SDK	05
Camera Setup and Operation	05
Installation Guide	06
Product Drawings	07
Multi-Camera Synchronization	08
Safety and Handling	08
Glossary of Terms	09

# 1. Product Brief

## Product Overview

The upgraded Astra 2 3D camera, released in 2023, is the successor to the widely used Astra series products. The camera is based on structured light technology and has been upgraded with Orbbec's latest custom ASIC for high quality depth processing, IMU and multi-camera sync.

Astra 2 is easy to set up and operate with the Orbbec SDK, and the camera delivers extremely accurate and reliable data for indoor operation.

## Product Features

- High quality depth data output from 0.6m to 8m
- Up to 30 fps at 1600X1200 depth resolution
- Up to 30 fps at 1920X1080 RGB resolution
- Multi-camera synchronization supported
- IMU supported

## 2. Product Specifications

Parameter	Specifications
<b>Model</b>	A30003-I5
<b>VID/PID</b>	0x2BC5/0x0660
<b>Technology</b>	Structured Light
<b>Shutter Type</b>	IR: Global Shutter; Color: Rolling Shutter
<b>Wavelength</b>	850nm

Mode	Resolution	FoV	FPS	Range	Format
<b>High Resolution</b>	1600 x 1200	H58.2°, V45.2°	5, 10, 15, 30	0.6m - 8m Ideal Range: 0.6m - 5.0m	Y16/Y14 /RLE
	800 x 600		5, 10, 15, 30		
	400 x 300		5, 10, 15, 30		
<b>Classic Resolution</b>	1280 x 960		5, 10, 15, 30		
	640 x 480		5, 10, 15, 30		
	320 x 240		5, 10, 15, 30		
<b>RGB</b>	1920 x 1080	16:9 H74.7°, V46.2° 4:3 H59.6°, V46.2°	5, 10, 15, 30		YUYV/ MJPEG
	1440x1080		5, 10, 15, 30		
	1280x960		5, 10, 15, 30		
	1280x720		5, 10, 15, 30		
	800x600		5, 10, 15, 30		
	640x480		5, 10, 15, 30		
	640x360		5, 10, 15, 30		
	400x300		5, 10, 15, 30		
	320x240		5, 10, 15, 30		
	320x180		5, 10, 15, 30		

Typical depth accuracy:  $\leq 0.16\%$  (1600 x 1200 @ 1m & 81% ROI),  $\leq 0.3\%$  (1600 x 1200 @ 2m & 81% ROI).  
 Max depth accuracy:  $\leq 0.5\%$  (1600 x 1200 @ 1m & 81% ROI),  $\leq 1\%$  (1600 x 1200 @ 2m & 81% ROI).  
 The test object is a reflectivity > 80% plane, and the reference range is 81% FoV (81% FoV is the remaining center 81% of the depth map area after cropping 5% of the top and bottom of the depth map). The root mean square of the distance sequence from all valid points in the area to the best-fit point of the fitted plane is calculated.  
 Measured object reflectivity > 10%, up to 8m distance depth data, but the actual accuracy varies with the distance and the object to be measured.

Parameter	Specifications
<b>Baseline</b>	75mm
<b>IMU</b>	6 DoF; Frequency range: 50-2,000Hz. Data format: float
<b>Mirror Mode</b>	Supported, non-mirror by default
<b>Processing</b>	Internal processing using Orbbec MX6600 ASIC
<b>Data Connection</b>	USB 3.0 / USB 2.0 USB Type-C for data and power
<b>Operating Modes</b>	High Resolution: High quality depth data. Classic Resolution: Original Astra series resolution
<b>Power Consumption</b>	Average < 3.0W (Peak 6.5W)
<b>Operating Environment</b>	0° -35°, 5%RH - 95 %RH (non-condensing), Indoor/Semi-Outdoor
<b>Anti-flicker</b>	50Hz & 60Hz
<b>Supported Functions</b>	D2C, Multi-Camera Sync
<b>Dimensions</b>	144.54 x 34.61 x 35.79 mm 144.54 x 45.35 x 38.64 mm (with mounting base)
<b>Weight</b>	195.2g/240.8g (with mounting base)
<b>Certifications</b>	Class, RoHS, FCC, CE, Reach, KC
<b>Installation</b>	1 x ¼-20 UNC 2 x M3

# 3. Product Information

## 3.1 Product Images



Front View



Rear view

## 3.3 Product Interfaces

The hardware interfaces of Astra 2 camera are shown in the figure below.

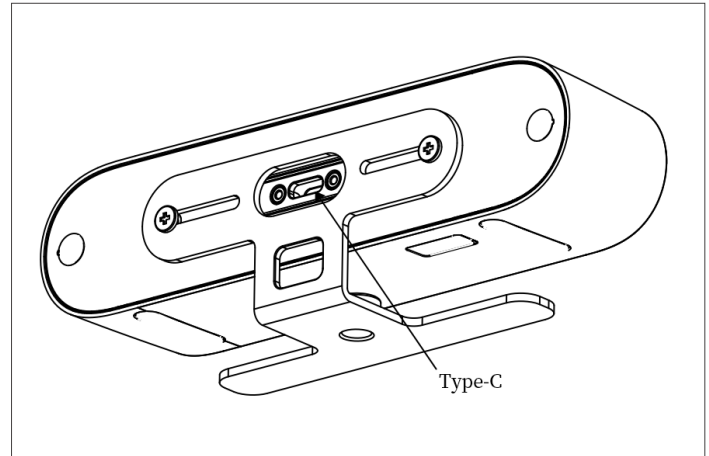

Type-C

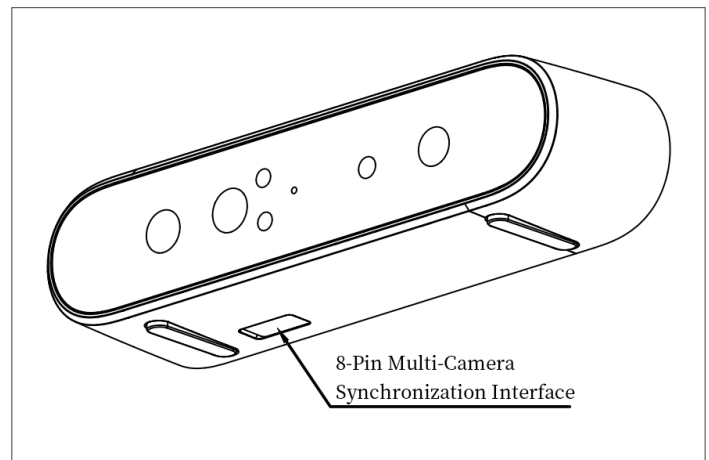

8-Pin Multi-Camera Synchronization Interface

## 3.2 Product Components

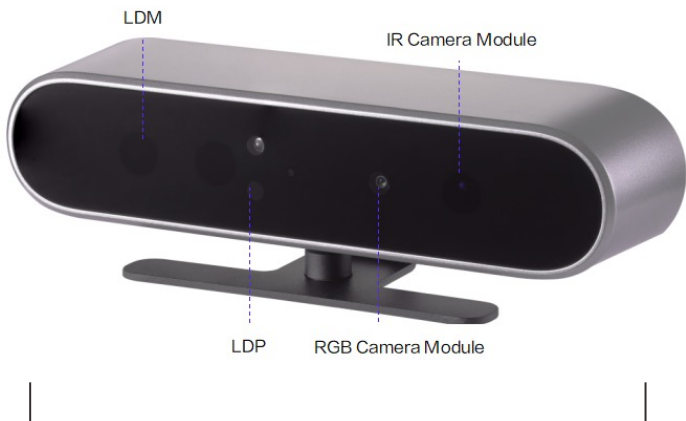

Astra 2 Components

## 3.4 Connection Type

Data Transmission	Synchronization
USB Type-C	8-Pin

## 4. Software Development Kit (SDK)

Orbbec SDK is a flexible and modular platform for easy camera setup with a rich set of APIs. It supports camera access, device setup and configuration, data stream reading, processing, viewing, RGB-D registration and frame synchronization.

### The functions include:

- Access and control of camera devices
- Control of frame synchronization and alignment
- Acquisition of point cloud data
- Orbbec Viewer for camera testing

Please check <https://www.orbbec.com/developers/orbbec-sdk/> for the latest SDK.

### Temperature sensor and recording

The temperature of camera core components – including laser temperature, IR sensor temperature and IMU sensor temperature – can be obtained through API commands.

## 5. Camera Setup and Operation

### Packing List

- Orbbec Astra 2 device
- USB Type-C to USB Type-C data + power cable

### Initialization and Operation

- Connect Astra 2 via the cable to the host PC.
- Download the Orbbec SDK from <https://www.orbbec.com/developers/orbbec-sdk/>
- Use Orbbec Viewer to validate that images can be streamed from all sensors with the following settings:
  - Depth camera: High Resolution, 1600x1200
  - RGB Camera: 1920x1080
  - IMU enabled
- If the camera is not responding or not being detected for any reason, please remove all cables from the camera and replug to the host PC to reset the camera state.

### Indicators

The indicator is ON by default while the device is operating and can be manually switched on/off through the SDK.

State of Indicators	Meaning	Next Steps
Solid	Powered ON and working correctly	Use the device.
Breathing	Powered on and data ready	Device is ready for use.
OFF	Low power standby	
Irregular Flashing	The device is in a faulty state	Unplug from the host to reset
Regular Flashing	Initialization & Firmware Upgrade	Make sure that the USB Type-C cable is connected to the device and host.

## 6. Installation Guide

Use outside of the specified conditions could cause the device to fail and/or function incorrectly. These conditions are applicable for the environment immediately around the device under all operational conditions. When used with an external enclosure, active temperature control and/or other cooling solutions are recommended to ensure that the device is maintained within these ranges.

### 6.1 Installation Recommendations

1. When using an external housing around the camera for dust proofing, use foam inserts or rubber gaskets between the front of the camera and the external housing.
2. Avoid the application of external forces to the camera chassis during the installation process.
3. Disassembling the chassis and mounting brackets will void the warranty.

### 6.2 Heat Dissipation

1. Avoid any direct heat sources around the camera.
2. Maximizing the space inside the external housing may help lower the operating temperature.

### 6.3 Transmittance Requirements

The current light transmission of the Astra 2 front cover glass lens is as follows:

1. Optical transmittance: 400nm-1050nm global transmittance at each point is above 95%.
2. Blue-purple region, 50% transmittance, corresponding wavelength less than 395nm.
3. Material flatness requirements of front cover lens:<0.005mm.
4. Glass is recommended.

Before changing the structural design of the camera, the protective lens in front of the camera lens must meet the requirements above.

### 6.4 Cable Design Guide

It is recommended to use the included USB Type-C cable. If a longer cable is needed, please select a USB certified cable that supports both power and data (1-1.5m length is recommended).

# 7. Product Drawings

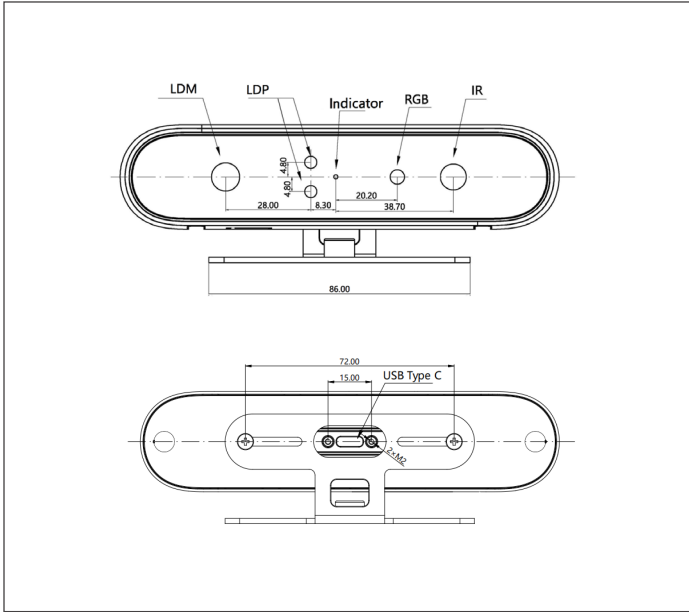

Front View

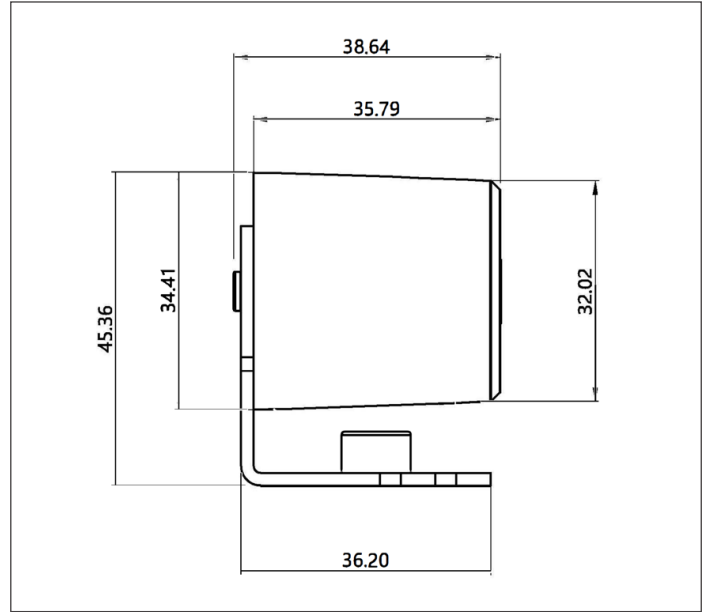

Side View

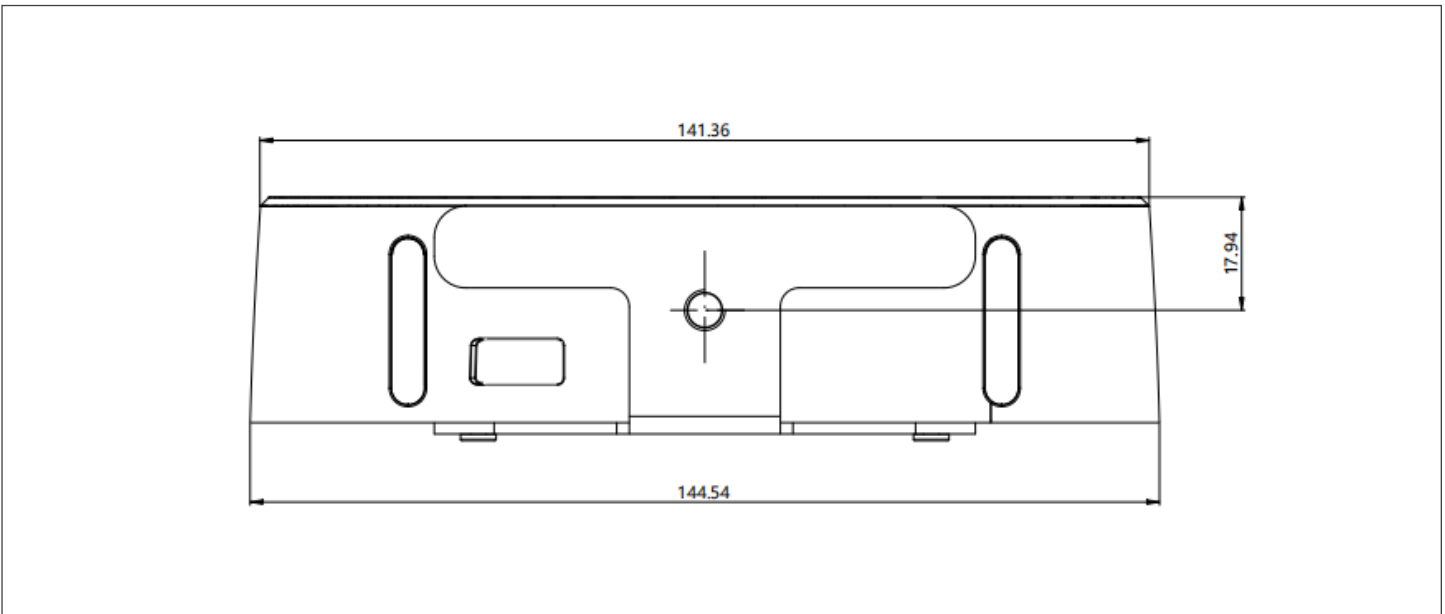

Bottom View

## 8. Multi-Camera Synchronization

### Advantages of a multi-camera setup

- Increase camera coverage in the given space and fill in the occlusions where a single camera may have blind spots.
- Capture multiple images of the same scene and scan objects from different angles.
- Increase the effective frame rate to greater than 30 frames per second (FPS).

Using an 8-pin connector and matching cable, a multi-camera and multi-sensor network can be designed. Recommended minimum delay setting is 4ms (please follow the instruction in the SDK).

Multi-camera and multi-sensor synchronization in different configurations can be designed with the optional Orbbec Multi-Camera Sync Hub Dev and Multi-Camera Sync Hub Pro accessories.

### Synchronization Interfaces of Astra 2 Camera

Pin	Definitions	Description
Pin_1	VCC	The default is 1.8V. When 3.3V or 5V drive voltage is provided on the VCC interface, the I/O level setting can be adjusted to 3.3V or 5V as required
Pin_2	GPIO_OUT	Reserved GPIO with low level outputs
Pin_3	VSYNC_OUT	Synchronous trigger signal: Active high. The high level provides the triggering signal for the secondary devices.
Pin_4	TIMER_SYNC_OUT	Pulse signal source, reset hardware timestamp of secondary devices.
Pin_5	RESET_IN	Hardware reset signal: Triggers the camera to power down and automatically power up and reset.  Detect the input signal: 20Hz / 50% duty cycle / more than 5 consecutive cycles, that is, judged as normal input signal, other signals filtered out; allowed fluctuations for frequency $\pm 1\text{Hz}$ , duty cycle $\pm 2\%$ .
Pin_6	VSYNC_IN	Synchronous trigger signal: Active high. Generated for the triggering/sync signal by the primary device, with a duration of 1ms.
Pin_7	TIMER_SYNC_IN	Hardware timestamp reset signal input, hardware timestamp clearing
Pin_8	GND	Ground

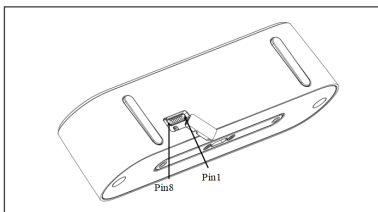

*\*The Pin sequence is shown with camera placed in bottom view.*

## 9. Safety and Handling

1. Follow the camera operation instructions. Improper operation may cause damage to internal components.
2. Do not drop or subject the camera to external force.
3. Do not attempt to modify the camera as modifications may cause permanent damage or inaccuracies.
4. The camera temperature may increase during long periods of continuous usage.
5. Do not touch the lens. Fingerprints on the lens may affect image quality.
6. Keep the product beyond the reach of children or animals to avoid accidents.
7. If the camera is not recognized by the computer, check if the cable meets the power/data transfer requirements and reinsert the USB for reconnection.
8. This product uses a Class 1 laser. Looking at the laser for more than 20s is not recommended.



# 10. Glossary of Terms

Term	Definition
D2C	Depth to Color function maps each pixel a on depth map to the corresponding color image according to the intrinsic and extrinsic parameters of depth camera and color camera.
Depth	Depth video streams are like color video streams except each pixel has a value representing the distance away from the sensor instead of color information.
Depth Camera	Includes the external interface and the depth imaging module, which is generally composed of the infrared projector, the infrared camera, and the depth computing processor.
FOV	Field of View (FoV) describes the angular extent of a given scene that is captured by a camera, which can be measured in horizontal, vertical, or diagonal .
I2C	I2C bus refers to a kind of simple bidirectional two-wire synchronous serial bus developed by Philips. It can be used for transferring information among devices connected to the bus with two wires.
IR Camera	Infrared camera.
IR Flood	IR floodlights are used to illuminate the environment.
ISP	Image signal processor, which is used for image post-processing.
MIPI	Mobile Industry Processor Interface (MIPI) is an open standard and specification formulated by the MIPI Alliance for mobile application processors.
PCBA	Circuit board that includes the depth computing processor, memory, and other electronic devices.
Point Cloud	A point cloud is a discrete set of data points in space.
SoC	System on Chip, an integrated circuit (IC) that integrates all components of a computing system.
TBD	To Be Determined. In the context of this document, information will be available in a later revision.

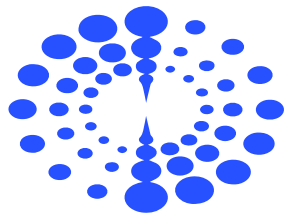

# ORBBEC